

TAMURA

Corporate Profile 2019



TAMURA CORPORATION

Contents

- **Corporate Outline/
Business Domain**
- **Applications**
- **Group Network**

■ Corporate Outline/ Business Domain



State of the Company

Capital: 11,829 million Yen
Number of employees: 5,021
Sales amount: 87,008 million Yen
President: Masahiro Asada
Listed in the first section of the Tokyo stock exchange

Sales amount=FY2018
Number of employees=Mar.2019

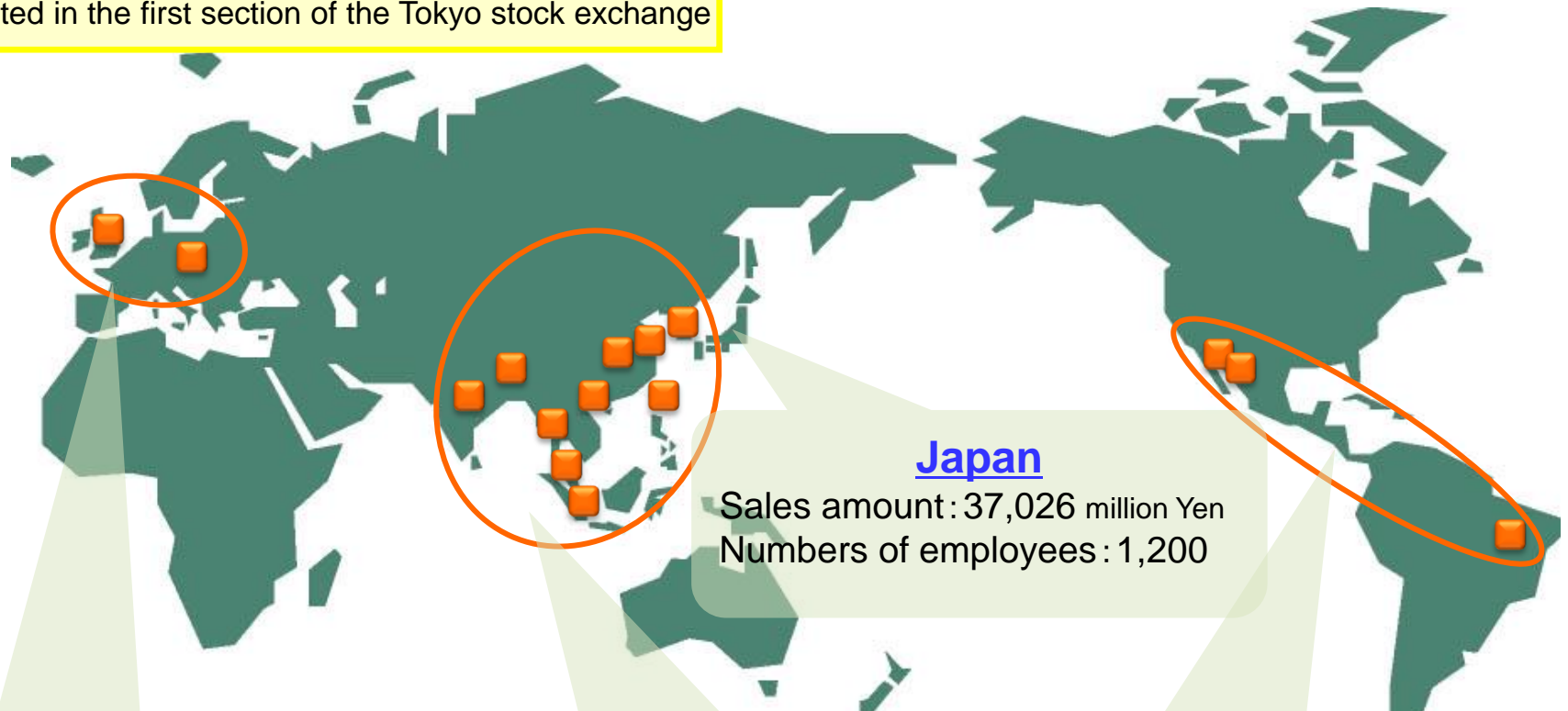

Europe

Sales amount: 8,716 million Yen
Numbers of employees: 253

Asia

Sales amount: 37,290 million Yen
Numbers of employees: 3,417

Americas

Sales amount: 3,975 million Yen
Numbers of employees: 151

Japan

Sales amount: 37,026 million Yen
Numbers of employees: 1,200

Sales / Operating Income

[100 million yen]

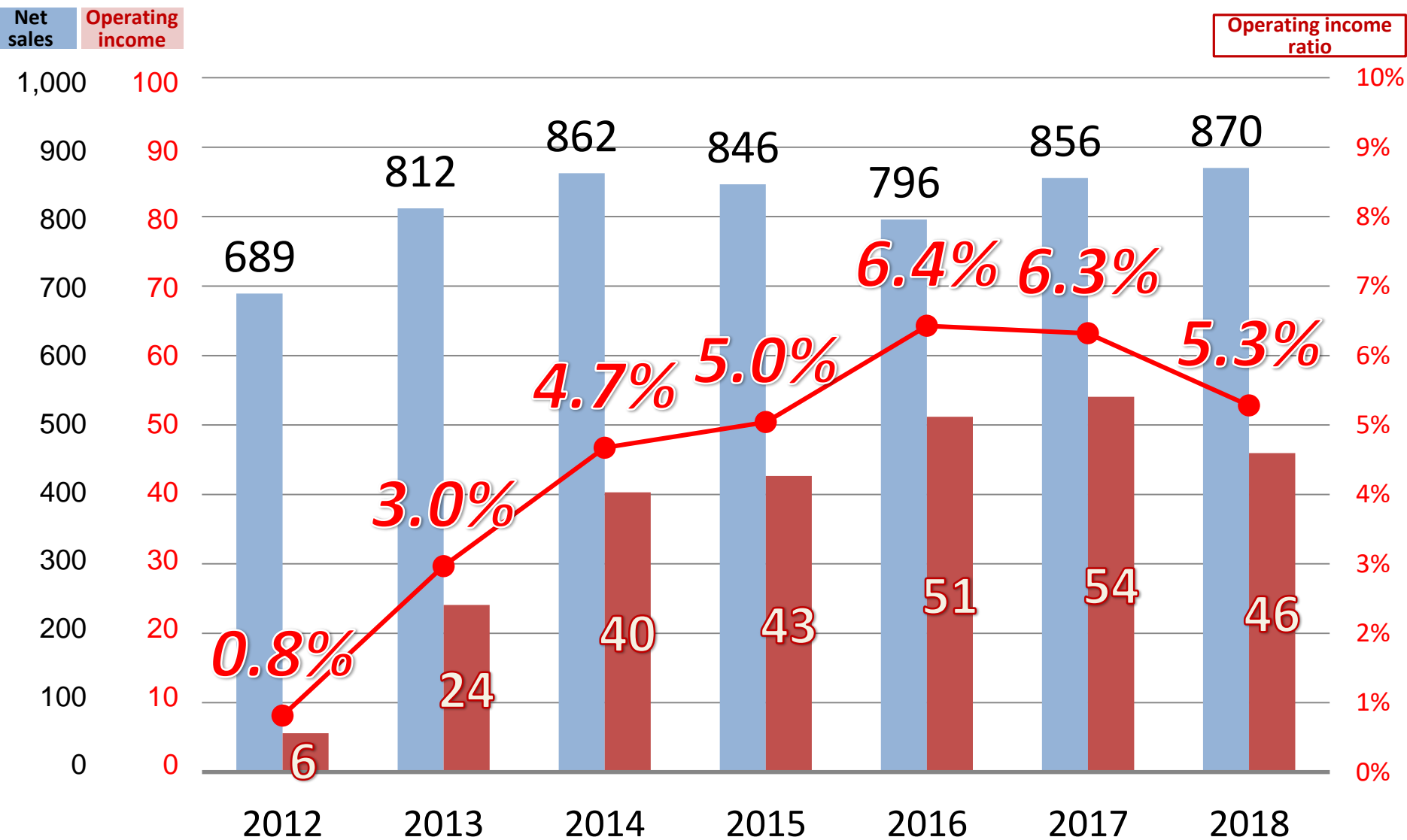

The History of TAMURA

1924 Established
Tamura Radio Store
in Shinjuku, Tokyo, Japan



We pursued
“good sound” !



1924~
Radio receiving sets
Gramophones



1930~
Transformers

Development of
transformers

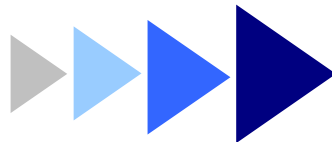

Electronic Components



1956~ Power supplies
1956~ Current Sensors
1994~ Piezoelectric
transformers
2008~ LED products

Development of
soldering technology

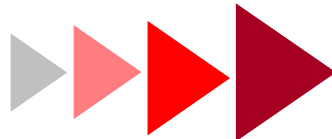

Electronic Chemicals / FA Systems



1956~ Flux
1957~ Solder paste
1961~ Resist ink
1968~ Soldering systems

Development of
**Information &
Communication
technology**

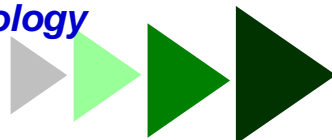

Information Equipment



1961~ Audio mixing
console
1976~ Transmission
monitoring device

Sales [¥100 million]

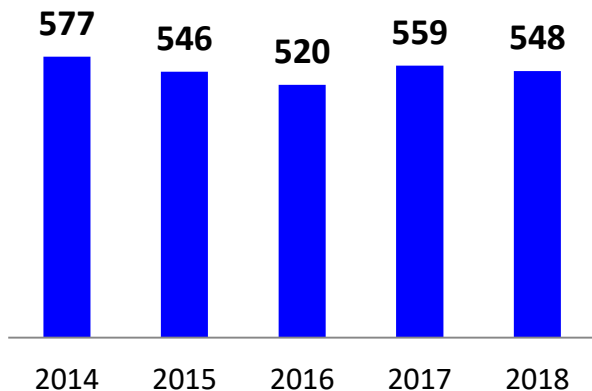

Sales Revenue Ratio

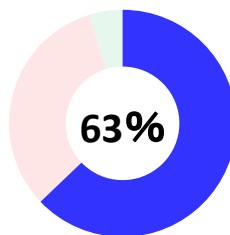

2018

Products

Transformers, Inductors, Reactors,
Choke coils, Current sensors

AC adaptors, Battery chargers,
Power modules, Industrial power supplies

Piezoelectric ceramic products

LED-related products



Sales [¥100 million]

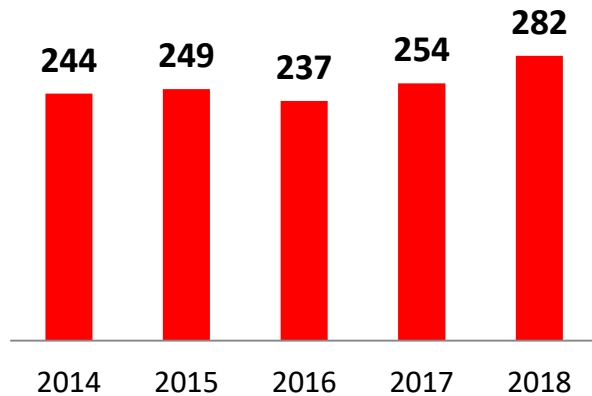

Sales Revenue Ratio

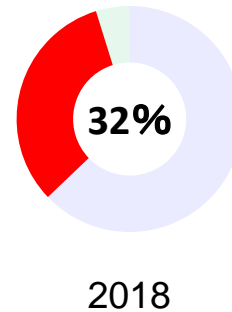

Products

Solder paste & Post-flux
Self Assembling Material

Solder resists for rigid & flexible PCBs
OSP(Pre-flux)
White reflective material,
Black absorbing material

Reflow soldering system
Wave soldering system
Spray fluxer & other peripheral devices

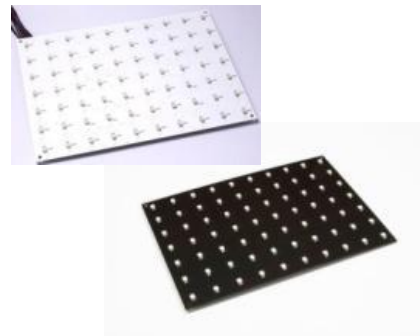

Sales [¥100 million]

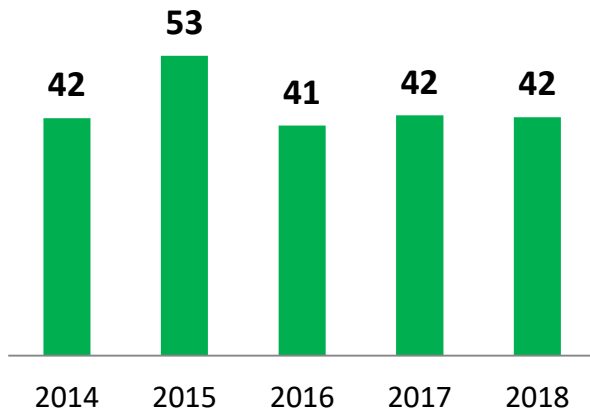

Sales Revenue Ratio

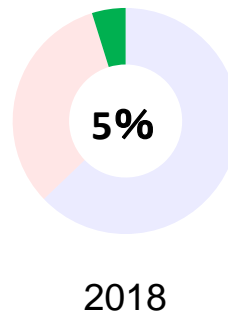

Products

Audio mixing console & Sound editor
& other equipment
for broadcast use

Wireless intercom
Wireless microphone

Communication network equipment
Security-related equipment
OEM products



NT880



NT660



NT110



OFDM

■ Applications





Power conditioner



導電性接合材

Self assembling material

导电性接合材料

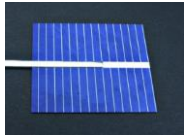

白色反射材

White reflective material

白色反射材料



リアクタ

Reactor

电抗器



電流センサ

Current sensor

电流传感器



Wind power generation

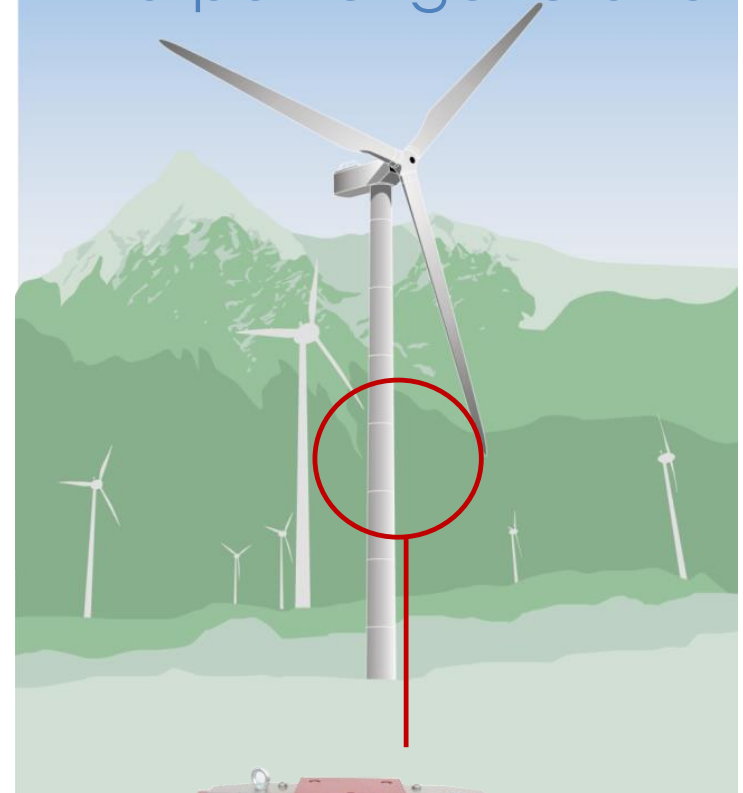

大型トランス・リアクタ

Large size transformer, reactor

大型变压器、电抗器

Solar power generation

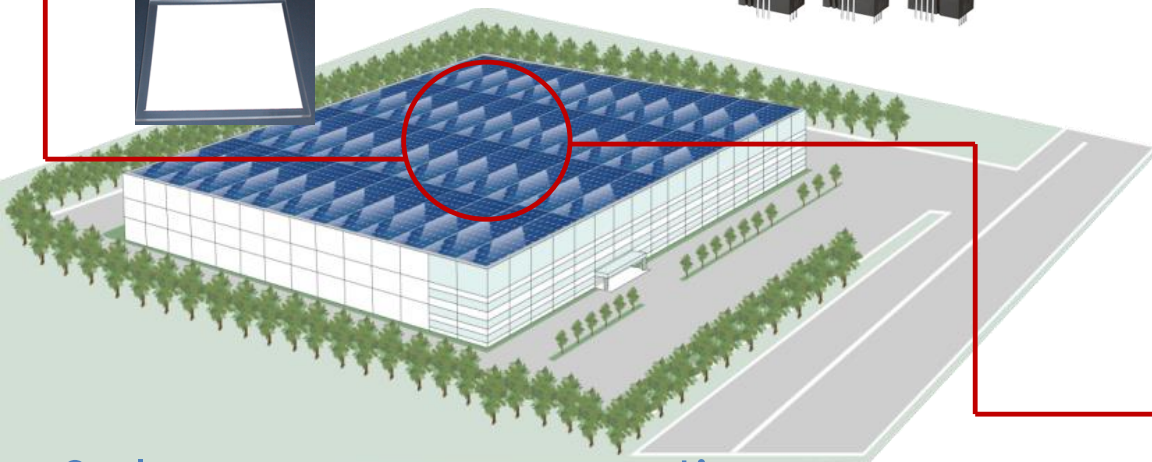

Machine room



● LED照明
LED lighting
LED照明



● エアコン用リアクタ
Reactors for air conditioner
空调用电抗器

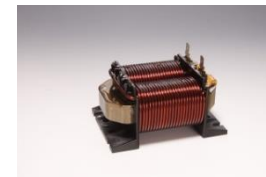

● ワイヤレスインターカム
Wireless intercom
无线内部通话系统

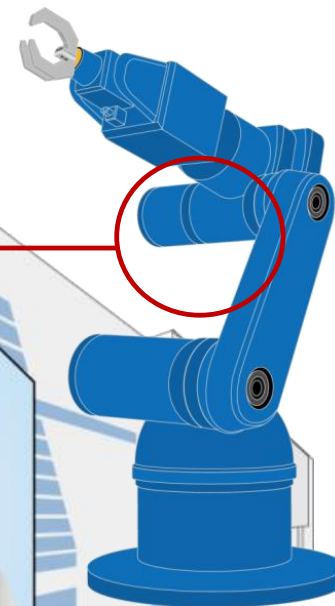

Industrial robot

● トランス・リアクタ
Transformers, Reactors
变压器、电抗器



● 電流センサ
Current sensors
电流传感器

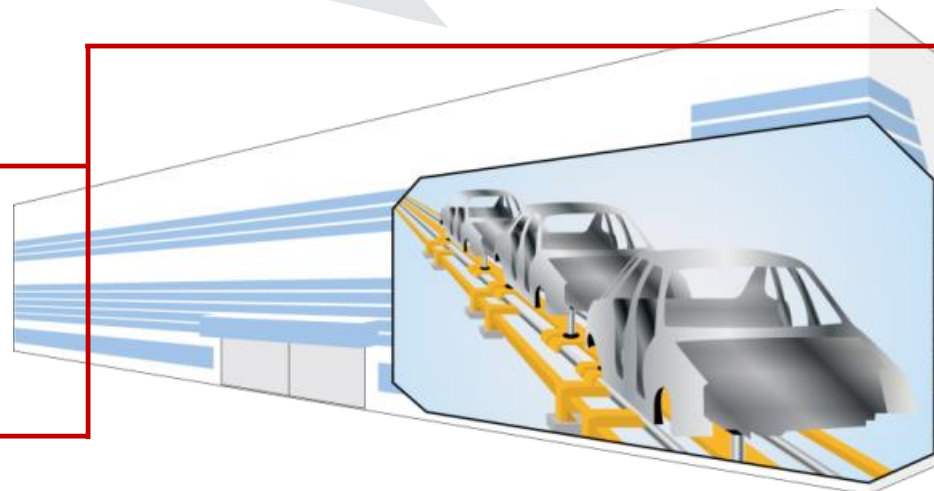

● **車載用リアクタ**
Automotive reactor
车载用电抗器

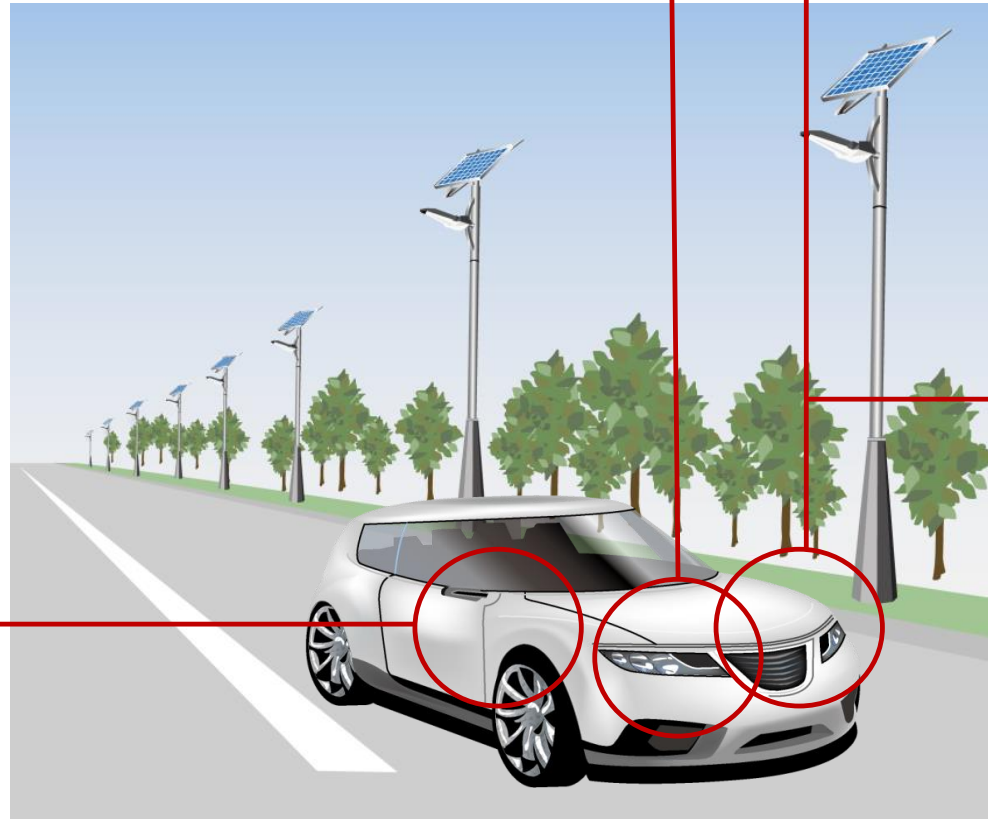

● **ソルダーペースト**
Solder paste
焊膏



● **ソルダーレジスト**
Solder resists
阻焊油墨



● **コイル**
Coils
扼流圈

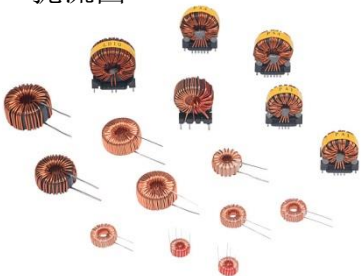

Station



● サインボード
Sign board
导向板



● ワイヤレスマイクロホンシステム
Wireless microphone system
无线麦克风系统



● 自動販売機用LED製品
LED product for vending machines
LED相关产品・自动售货机



● 交通信号
Traffic light
LED相关产品・交通信号



● 大型トランス
Large size transformer
大型变压器

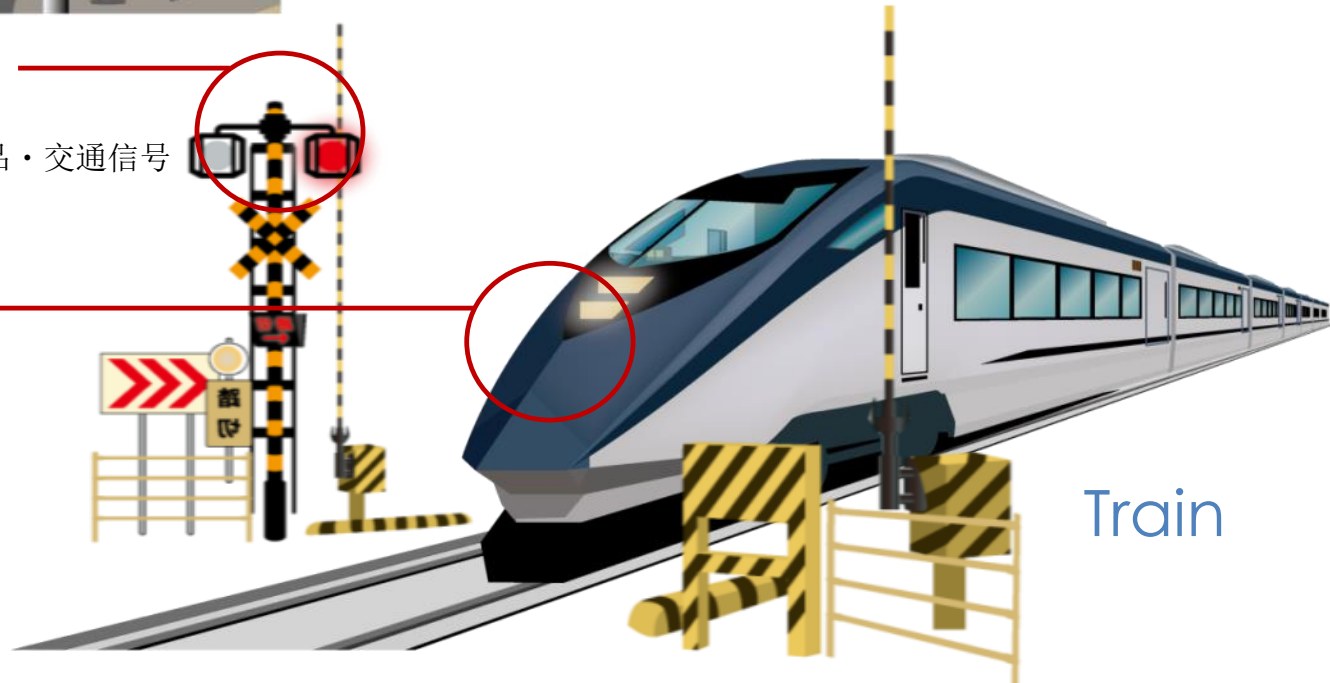

Train

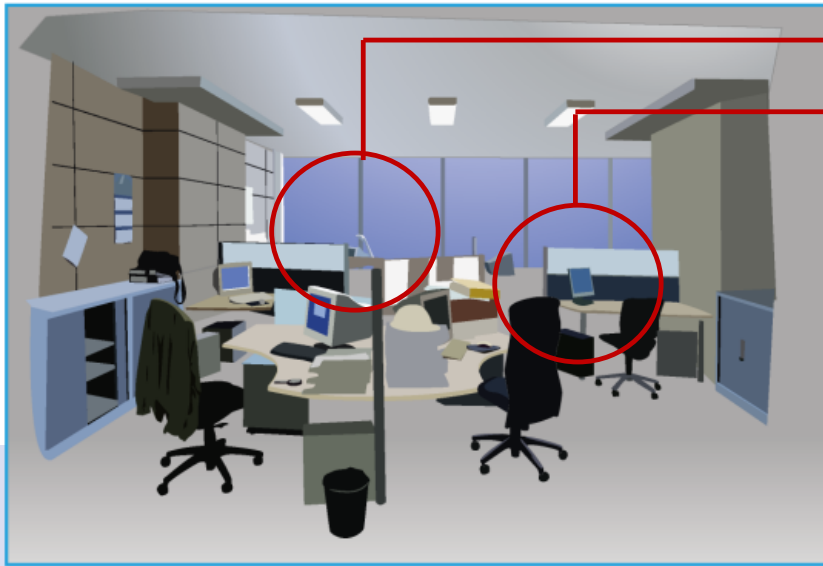

● **ACアダプタ**
AC Adaptors
AC适配器



● **圧電トランス**
Piezoelectric transformers
压电陶瓷产品



Laser Printer

Smart phone
Tablet PC



● **USB充電器**
USB battery charger
USB充电器



● **黒色吸収材**
Black absorbing material
黑色吸收材料



● **導電性接合材**
Self assembling material
导电性接合材料

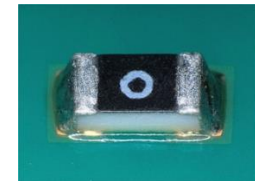

● **透明フレキシブル絶縁材料**
Transparent flexible insulating material
透明柔性绝缘材料





音声調整卓
Audio mixing console
广电用调音台

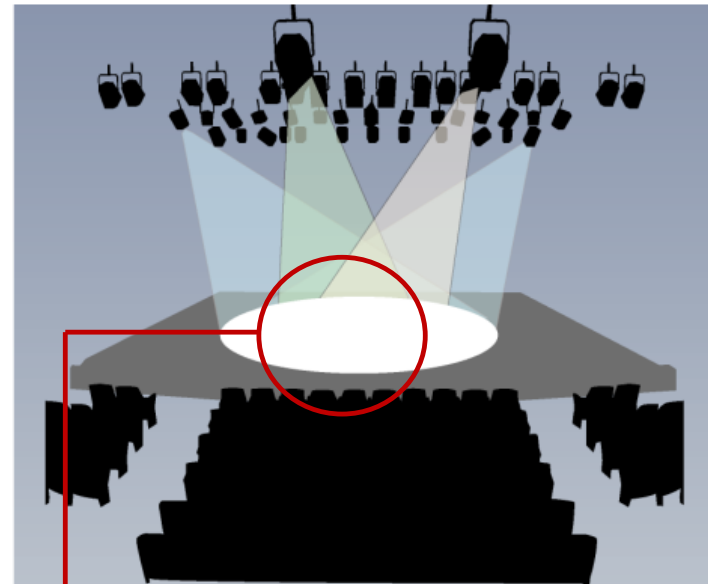

ワイヤレスマイク
Wireless microphone
无线麦克风



ワイヤレスインターカム
Wireless intercom
无线内部通话系统



実装プロセス

JISSO Process 表面貼装

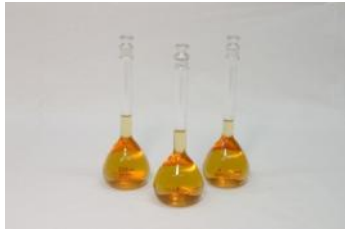

● **フラックス**
Flux
助焊剂



● **ソルダーペースト**
Solder paste
焊膏



● **ソルダーレジスト**
Solder resists
阻焊油墨



● **リフローはんだ付装置**
Reflow soldering system
回流装置

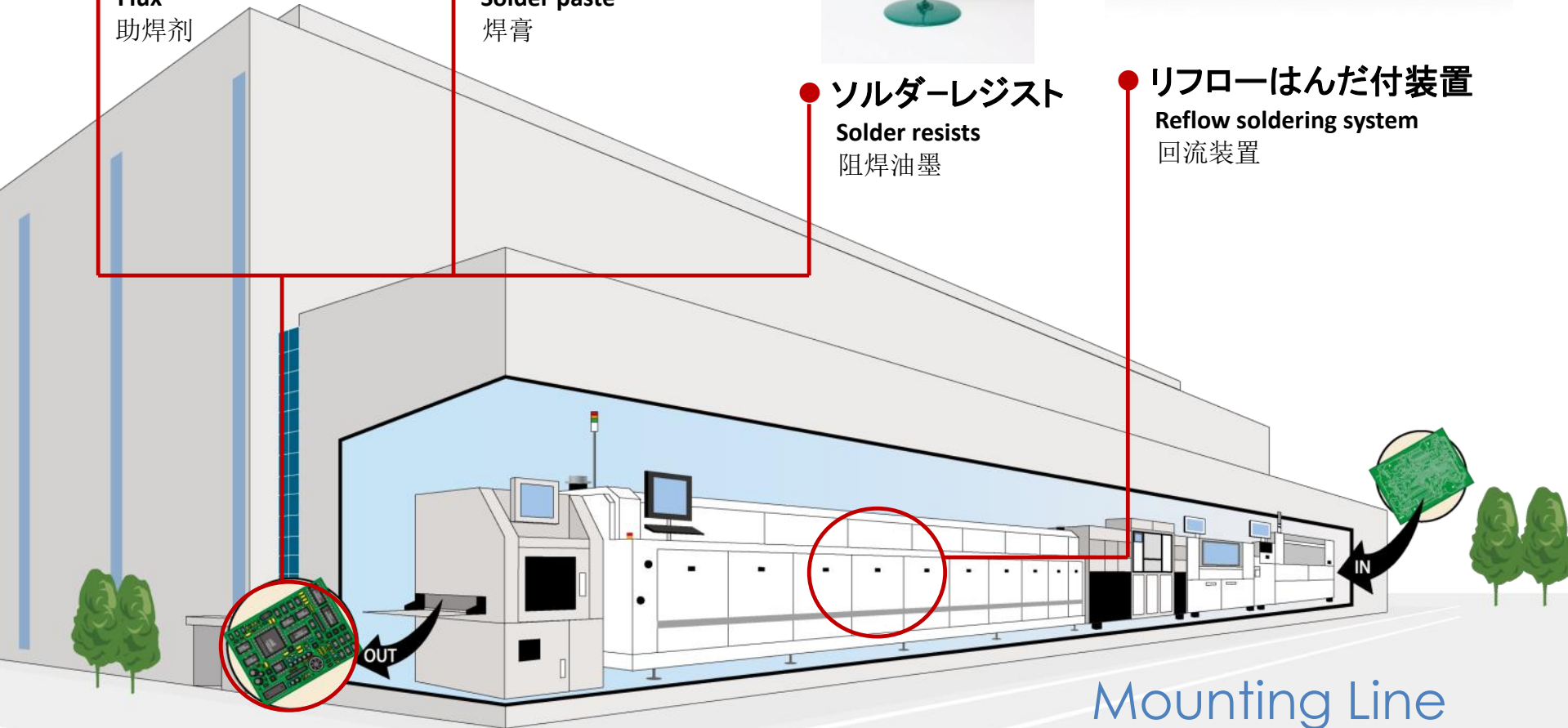

Mounting Line

Group Network



Group Network - Japan

○: Sales □: Factory △: R&D

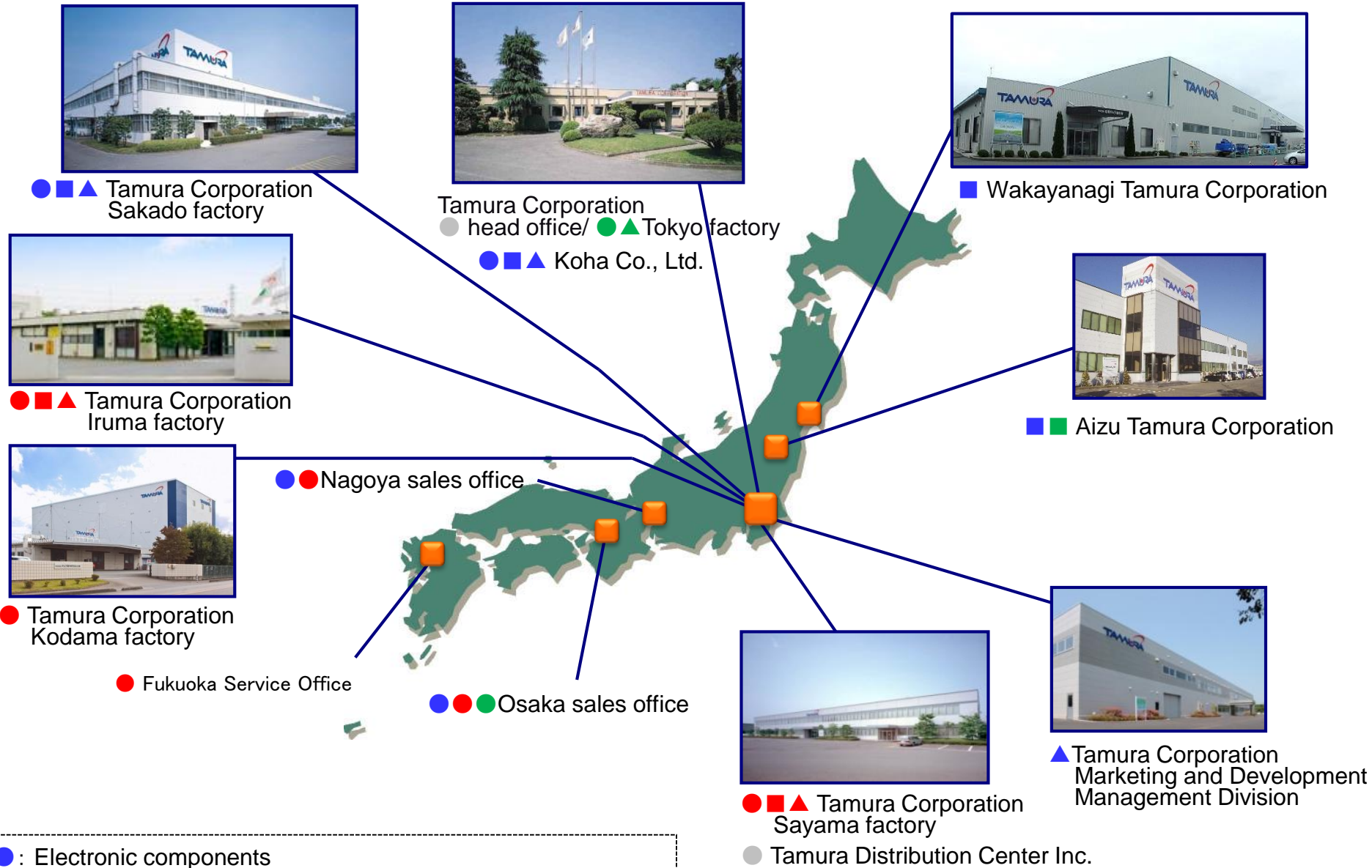

● : Electronic components
 ● : Electronic chemicals / FA systems
 ● : Information Equipment ● : General and administrative

Group Network - Overseas

○: Sales □: Factory △: R&D

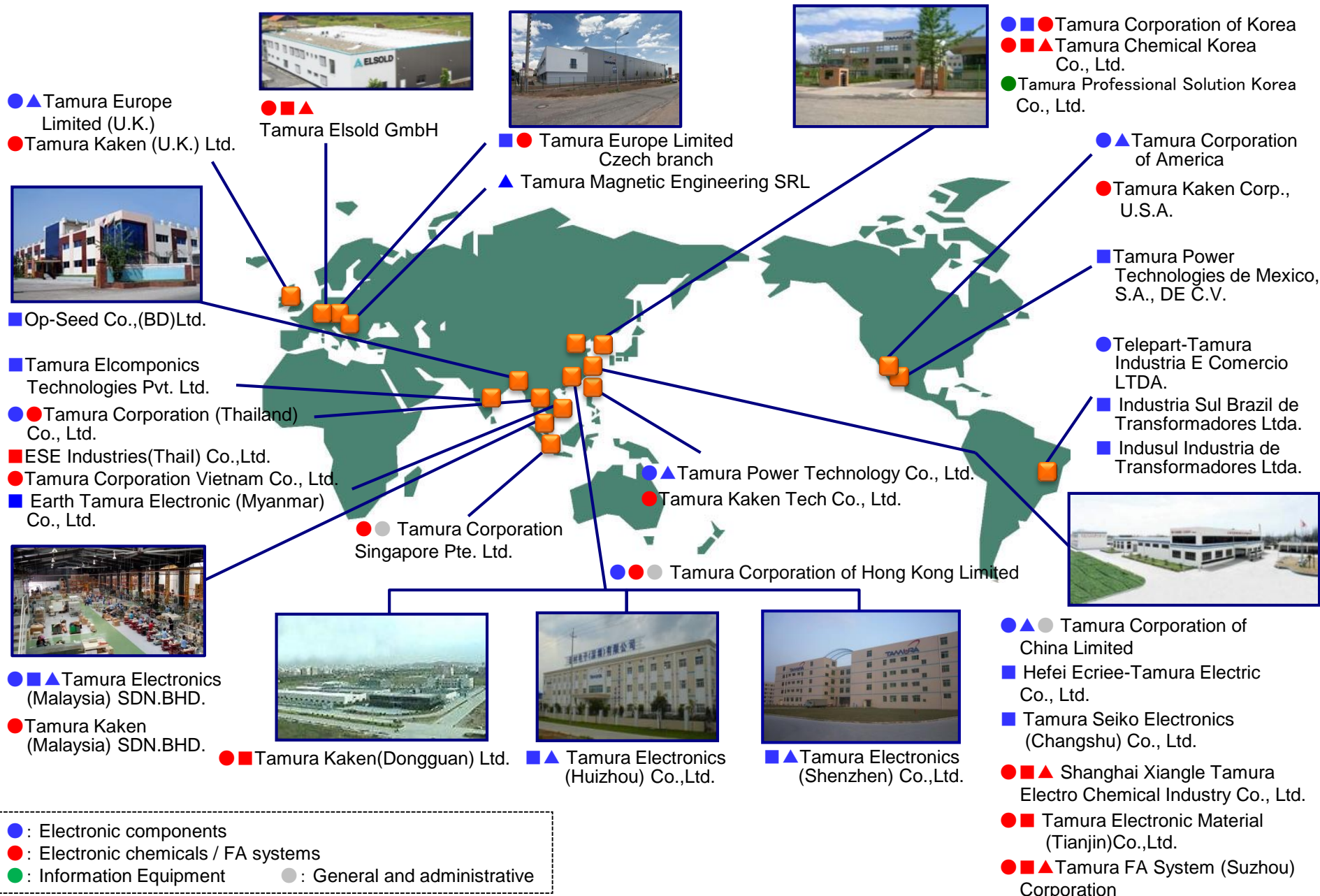



TAMURA CORPORATION

<http://www.tamura-ss.co.jp/>

*

— Publication —

Corporate Management dev.

May 10, 2019 Ver.E19-1