

LSUC 002R8L 0450F EA

The Ultracapacitor, also known as double-layer capacitor, stores energy by means of a static charge as opposed to a battery

It is used for energy storage applications which undergo very frequent charge and discharge cycles at high current and short duration. It features a wide operating temperature range, making it an ideal energy storage device for extreme environments.

It can be applied in wind power, hybrid systems, industrial automation, power backup and stabilization. Imagination is its only boundary.



PERFORMANCE SPECIFICATIONS

Rated Voltage(Nominal)	2.8 V
Surge Voltage	3.0 V
Capacitance	450 F
Capacitance Tolerance	0% / + 20%
Max. ESR DC	3.0 mΩ
Max. ESR AC (1 kHz)	2.8 mΩ
Typical ESR DC ¹	-
Typical ESR AC ¹	-
Total Energy	0.49 Wh
Max. Current ²	268 A
Leakage Current ²	< 1 mA

¹ Internal control value

² The stated maximum peak current should not be used in normal operation and is only provided as a reference value.

THERMAL SPECIFICATIONS

Max. Continuous Current $\Delta T=15\text{ }^{\circ}\text{C}^7$	25 A
Max. Continuous Current $\Delta T=40\text{ }^{\circ}\text{C}^7$	40 A
Thermal Resistance ($^{\circ}\text{C}/\text{W}$) ⁸	8.3

⁷Initial state value.

⁸The specification is calculated under limited conditions.

MECHANICAL SPECIFICATIONS⁹

D1 + 1.0 mm	35
L ± 2.0 mm	71
Mount Options	Lug
Weight	88 g
Safety Vent	Bottom Notch

⁹Dimensions and weight may differ with terminals and it may change without notice.

ENVIRONMENTAL SPECIFICATIONS

Operating Temperature	-40°C to 65°C
Operating Humidity (RH)	Up to 95%, condensing
Storage Conditions	-20°C to 25°C Up to 85% RH

LIFE INFORMATION

Endurance Life (65 °C)	1500hr
Capacitance Change ³	< 20%
ESR DC Change ⁴	< 100%
Projected Life (25 °C)	10 Years
Capacitance Change ³	< 20%
ESR DC Change ⁴	< 100%
Projected Cycle Life (25 °C) ⁵	500,000 Cycles
Capacitance Change ³	< 20%
ESR DC Change ⁴	< 100%
Shelf Life (25 °C) ⁶	4 Years

³ Decrease from minimum Capacitance value.

⁴ Increase from Max. ESR value.

⁵ Cycle Life may vary for different working conditions. (e.g. voltage or temperature)

⁶ Stored uncharged state under appropriate storage conditions.

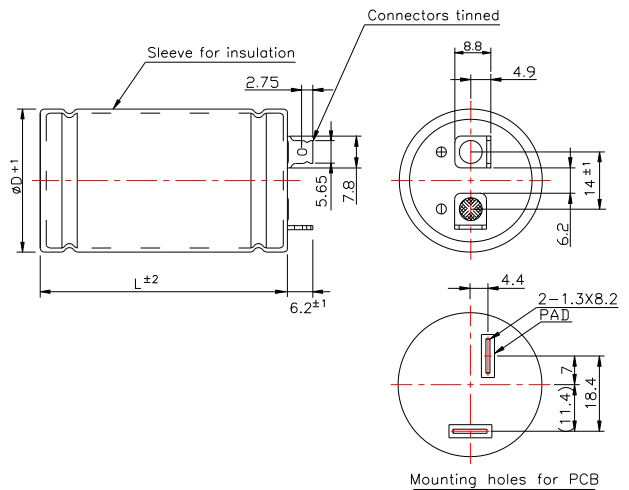

COMPLIANCE SPECIFICATIONS

Certifications	UL810A – MH46367
Environmental	RoHS, REACH
Shock & Vibration	IEC 60068-2-27 : 2008 IEC 60068-2-6 : 2007

VERSION HISTORY

Current Version	Previous Version	Date	Author	Change Description
A	-	2017-07-27	Horim Kang	Initial version of Specification
B	A	2020-04-10	Horim Kang	Data sheet amendment
C	B	2021-04-22	Insoo Park	Data Sheet revision

Markings

- Positive / Negative terminal
- Serial number
- Part number
- Warning marking

Accessories

Notice : Product dimensions and specifications may change without notice. Please contact LS Mtron for any technical specifications.